



9469 South Bagley Park Road  
West Jordan, Utah 84088  
Phone: 801.280.2182 Fax: 801.280.2183

M-T 7:00am to 5:30pm  
F 7:00am to 12:00 noon



9469 South Bagley Park Road  
West Jordan, Utah 84088  
Phone: 801.280.2182 Fax: 801.280.2183

Thank you for considering Stair Fittings, Inc. for your stair part needs. We are pleased to offer you the finest stair parts in the industry and hope that this catalog and pricing guide will assist you with your selections. Many items in the price guide are in stock and ready for immediate pick-up, shipment or delivery.

### **Product Information:**

**Stock Items:** We mill our linear product to the longest lengths possible. Oak, Maple and Cherry will range from 10 feet to 16 feet. Alder and Knotty Alder are generally 8 to 10 feet. We will do our best to fill orders to required lengths, but the customer is required to buy additional footages, in the event we do not have the exact length.

**Special Orders:** Custom orders are non-cancelable once production has begun. A 50% deposit is required at time of order placement.

**Wood Variation:** Color, tone, grain, sapwood, knots and mineral streaks occur naturally in wood. Although we do use FAS or better lumber and AWL grading guidelines, some variation will still be present. These variations should not be considered defects. Splits, checking and un-even machine marks are considered defects.

### **Sales Policies:**

**Terms:** All sales are COD unless sold to a House Account. House accounts may be established with credit approval. Terms are net 30 days. A 1.5% per month charge will be applied to all past due accounts. No Sales will be made to accounts with balances past due of more than 30 days, or a history of late payments.

**Returns:** All returns are subject to a 25% restocking charge. Special orders are non-returnable. All returns must be made no later than 30 days from the date of the original purchase, and must be accompanied by the original sales invoice. Credit will be given on sales items that are returned in perfectly sellable condition, and in their original boxes. Painted, primed, stained, dirty or cut material is not returnable. The customer is responsible for all freight charges on returns. All returns must be pre-approved.

**Defects:** We will replace any material found to be defective upon inspection. Replacement or credit is limited to material only. No credit or adjustments will be made for finishing or labor.

**Freight:** Customers are responsible for all freight charges (including back order shipments). UPS charges may be added to invoices and Common Carrier Shipments will be sent "collect." UPS freight damage must be reported to Stair Fittings immediately. Common Carrier freight claims are the sole responsibility of the customer.

**Other:** Stair Fittings reserves the right to change, modify or delete stock without advance notice. Prices and/or discounts are subject to change without notice.

**Hours:** 7:00 A.M. to 5:30 P.M. Monday Thru Thursday. 7:00 A.M. to 12:00P.M. Friday



# BOX NEWELS

Box Newel Size: 4" 5" and 6"  
 Other Sizes Available Upon Request  
 Solid Newels Available Upon Request

## Craftsman

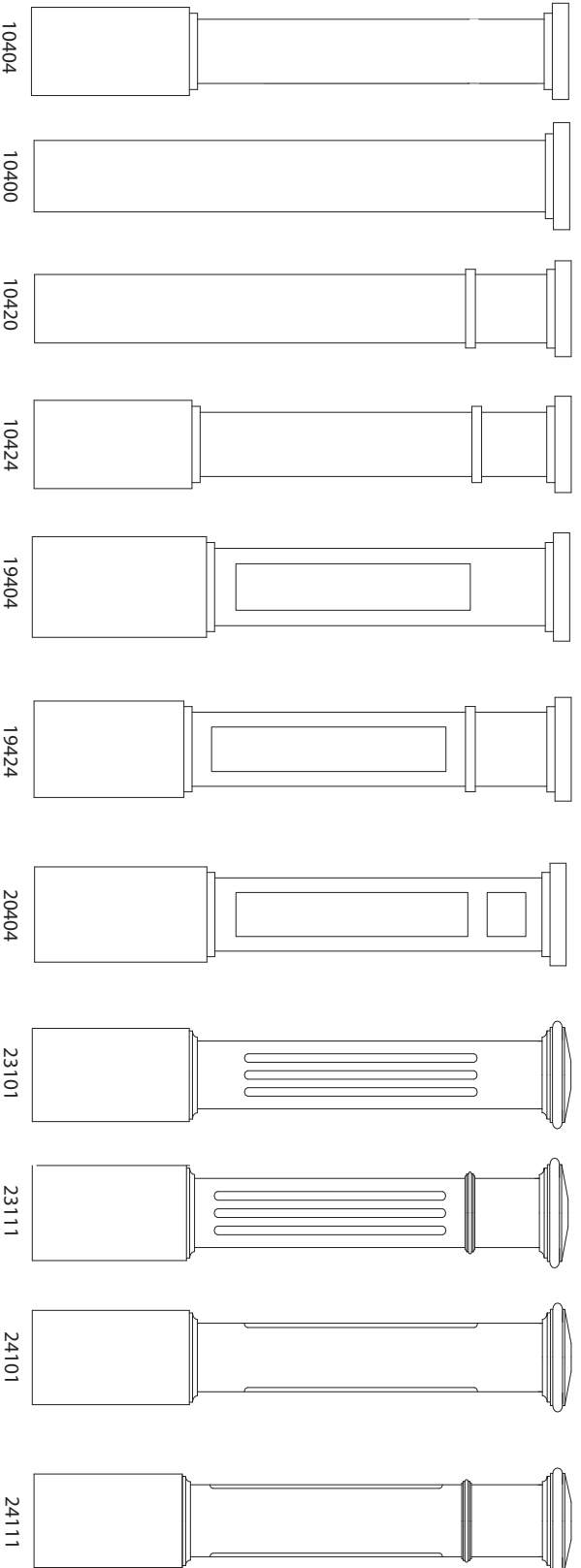

## Flute

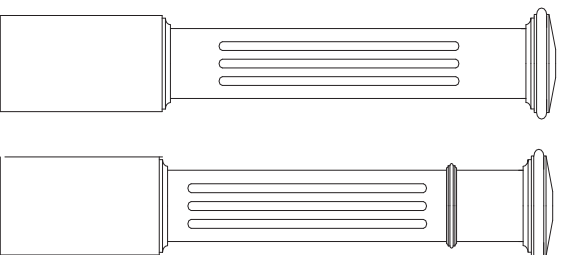

## Chamfor

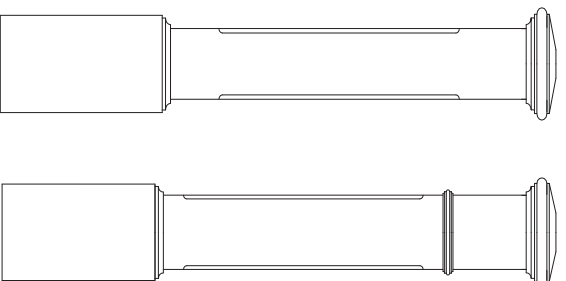

## Traditional

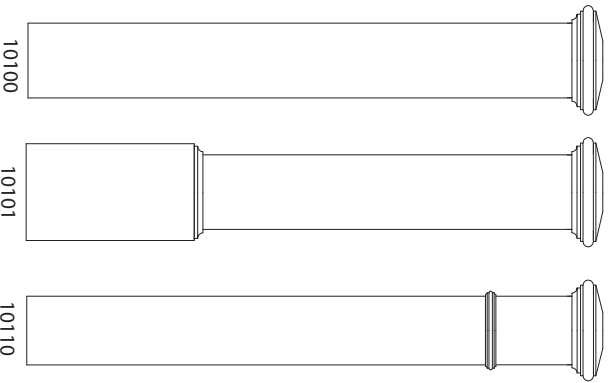

## Planton

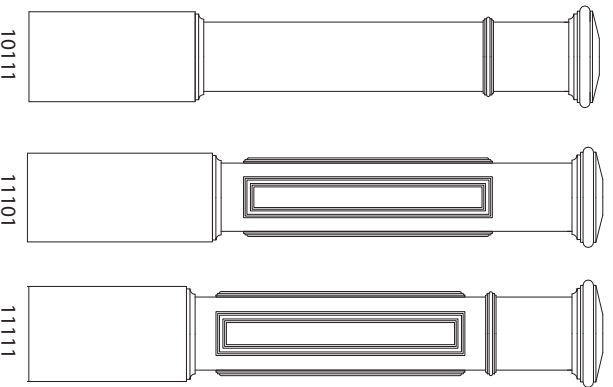

## Raised Panel w/Panel Cap

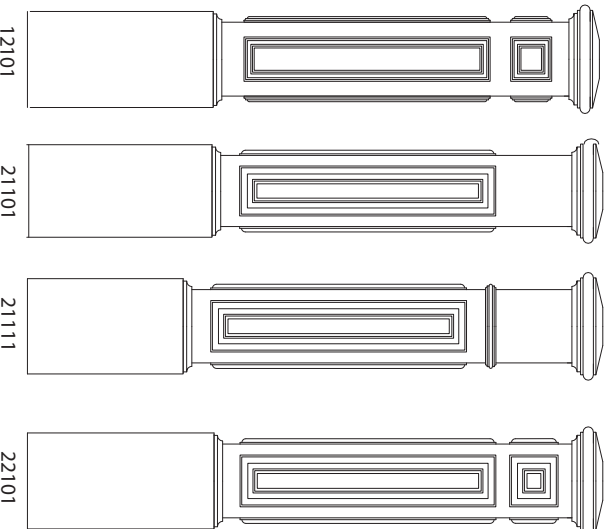

## Raised Panel

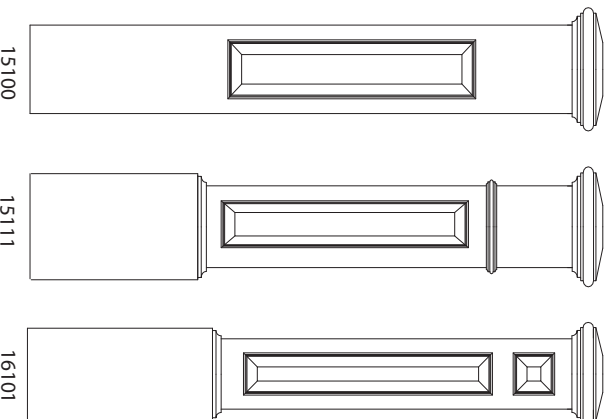



9469 South Bagley Park Road  
West Jordan, Utah 84088  
Phone: 801.280.2182 Fax: 801.280.2183

# Handrail

Available in Oak, Maple and Alder.  
Available in other species upon request.  
Other profiles available. 10' + lengths  
may have scarf joint in cap layer.

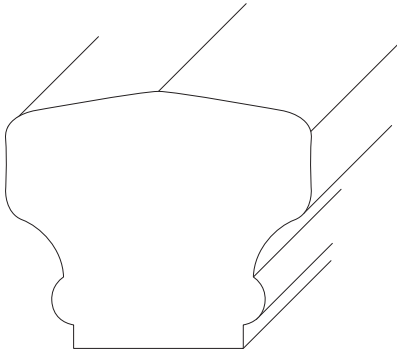

**101 - 1**  
2 1/2" (W) x 2 1/8" (H)

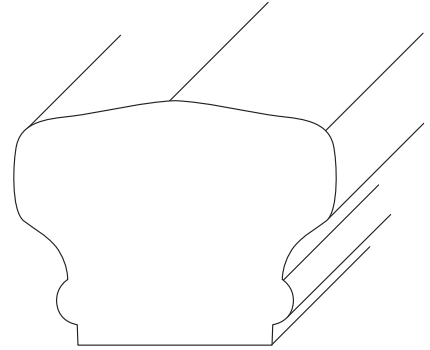

**102 - 1**  
2 3/4" (W) x 2 1/8" (H)  
(1 5/8" bottom)

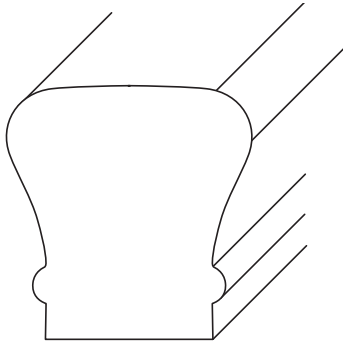

**106 - 1**  
2 1/4" (W) x 2 3/8" (H)  
(1 1/2" bottom)

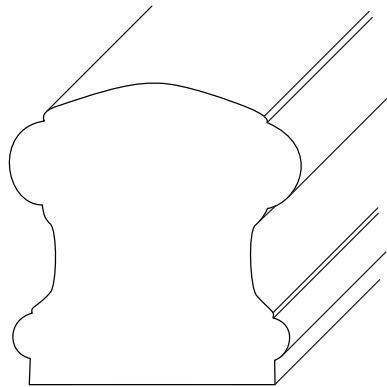

**103 - 1**  
2 3/4" (W) x 2 3/4" (H)  
(2 1/4" bottom)

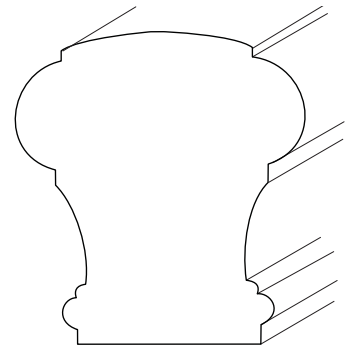

**104 - 1**  
2 3/4" (W) x 2 3/4" (H)

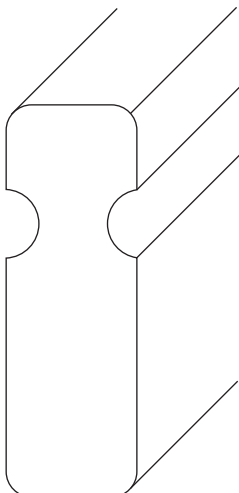

**559 - 5**  
(1 5/8" x 5")

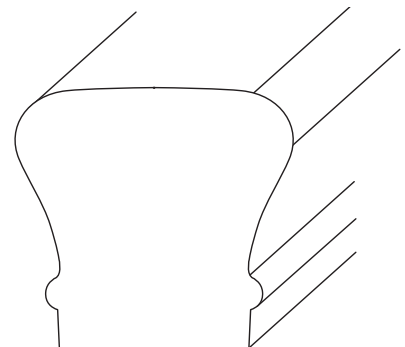

**6210**  
2 5/8" (W) x 2 3/8" (H)



9469 South Bagley Park Road  
West Jordan, Utah 84088  
Phone: 801.280.2182 Fax: 801.280.2183

# Handrail

Available in Oak, Maple and Alder.  
Available in other species upon request.

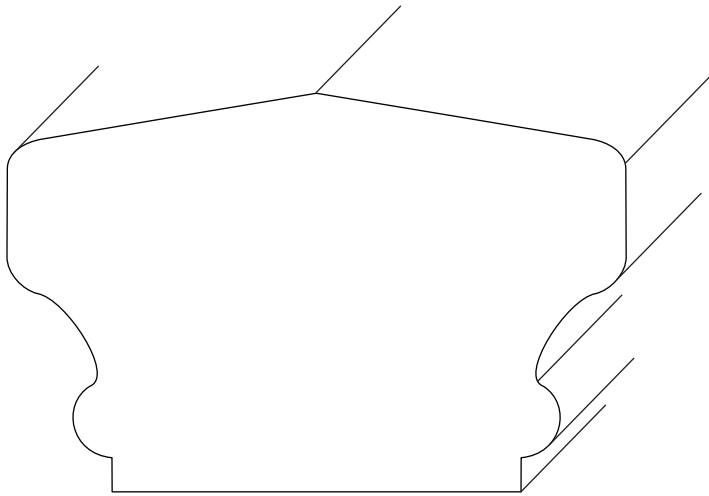

**102-3**  
3 1/4" x 2 1/8"

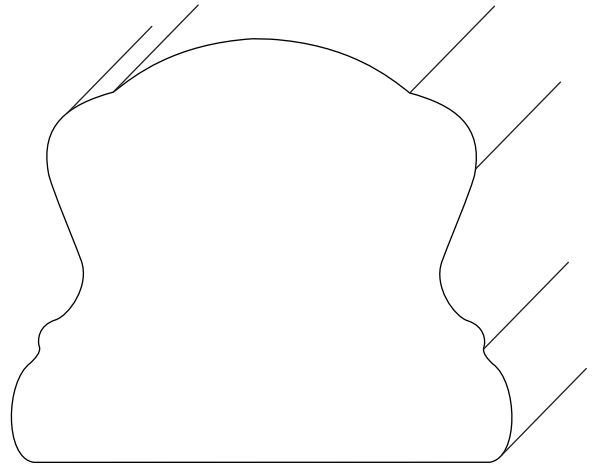

**108-1**  
2 1/4" x 2 5/8"

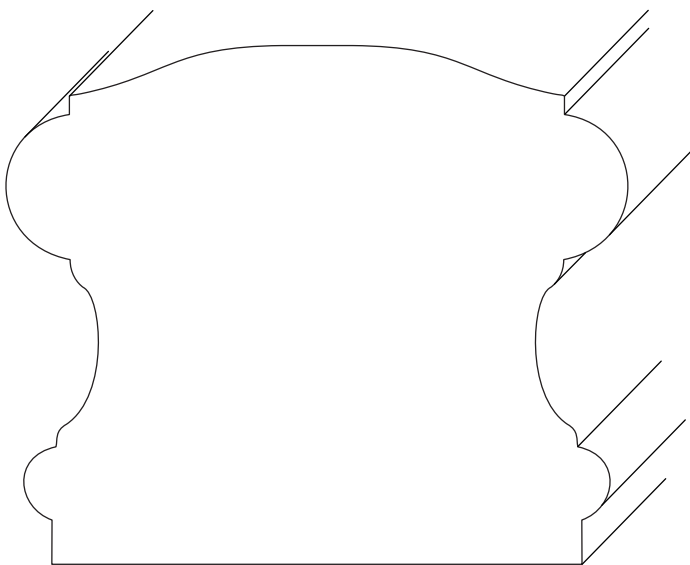

**103-3**  
3 1/4" x 2 3/4"

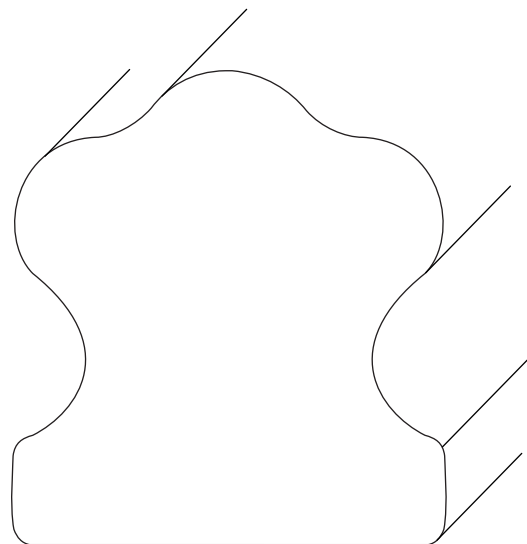

**650-1**  
2 1/4" x 2 1/2"



9469 South Bagley Park Road  
West Jordan, Utah 84088  
Phone: 801.280.2182 Fax: 801.280.2183

# Handrail

Available in Oak, Maple and Alder.  
Available in other species upon request.

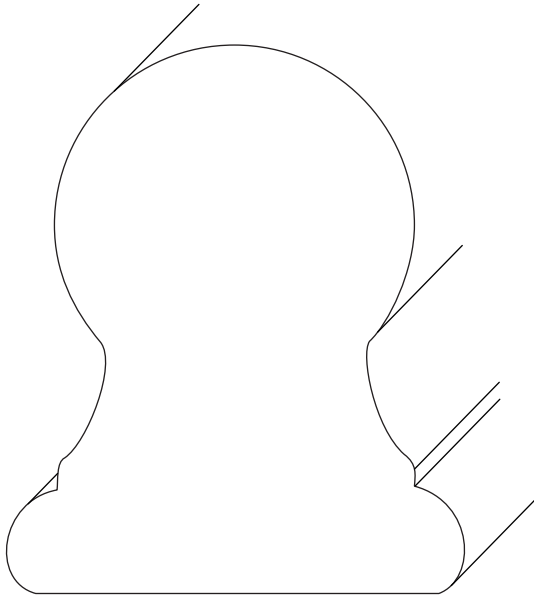

**109-1**  
2 3/8" x 2 7/8"

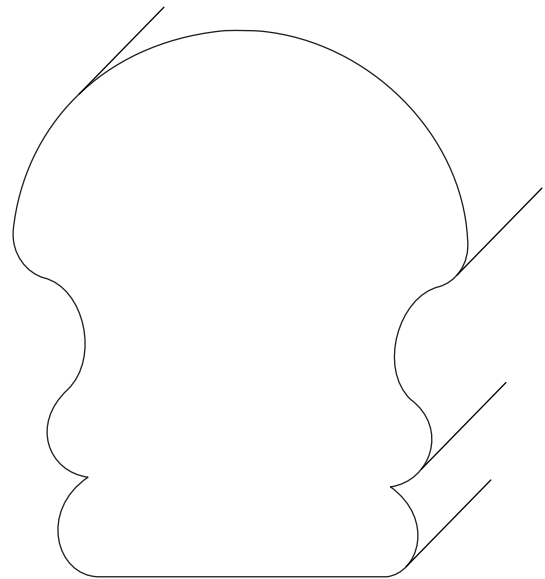

**107-2**  
2 3/8" x 2 7/8"

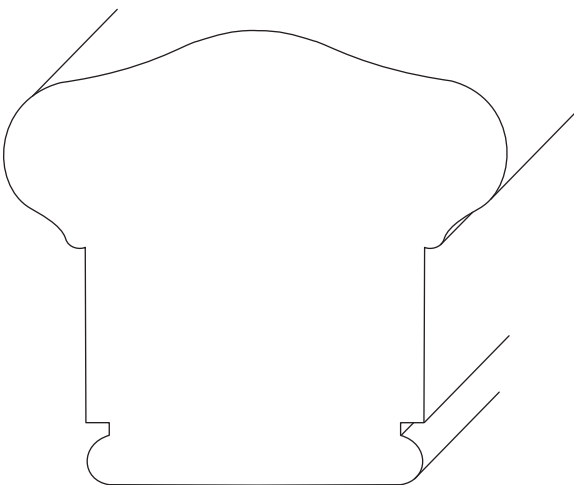

**110-1**  
2 5/8" x 2 3/8"

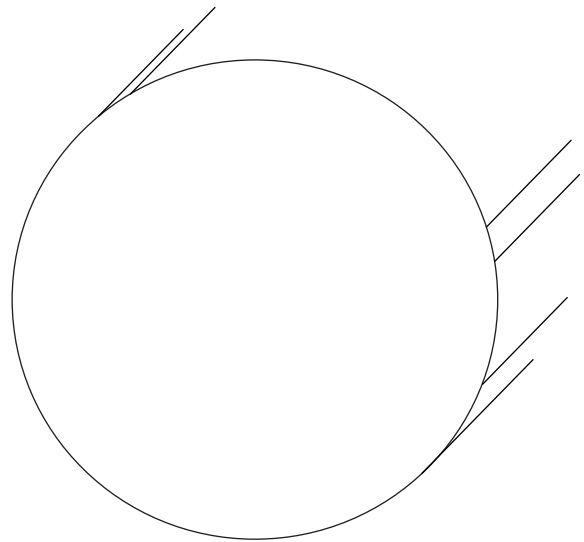

**Round**  
2 1/2"



9469 South Bagley Park Road  
West Jordan, Utah 84088  
Phone: 801.280.2182 Fax: 801.280.2183

# Handrail

Available in Oak, Maple and Alder.  
Available in other species upon request.

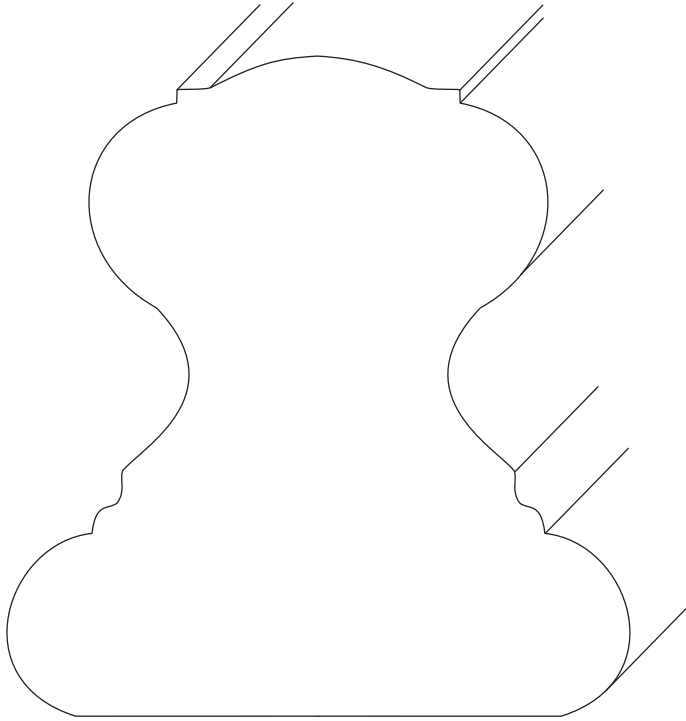

**111-1**  
3 1/2" x 3 5/16"

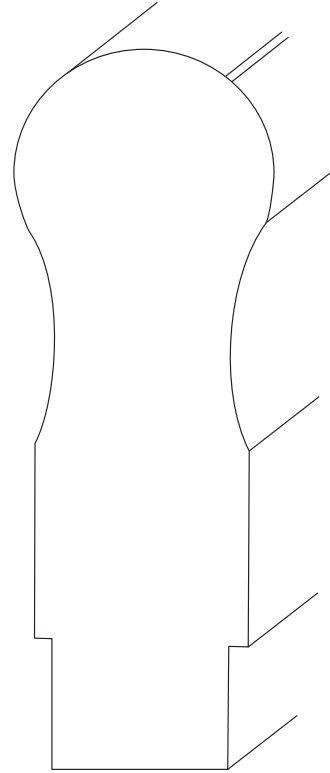

**112-1**  
1 1/2" x 4 1/4"

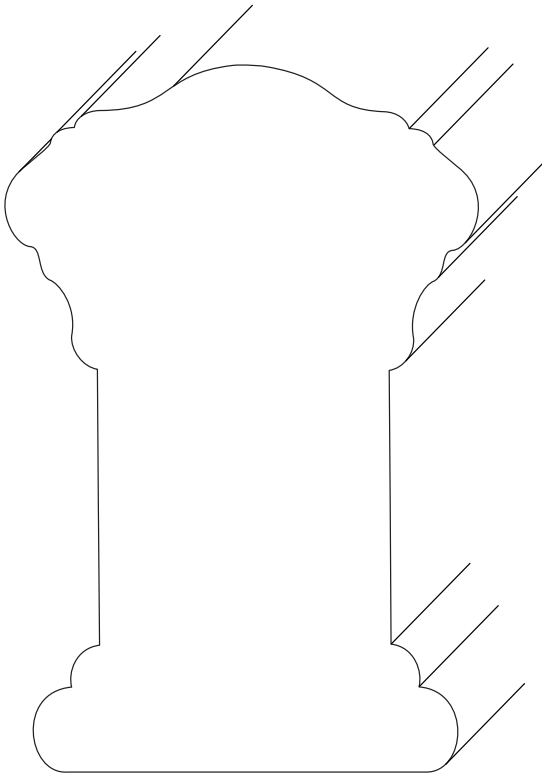

**113-1**  
3 1/2" x 3 5/16"

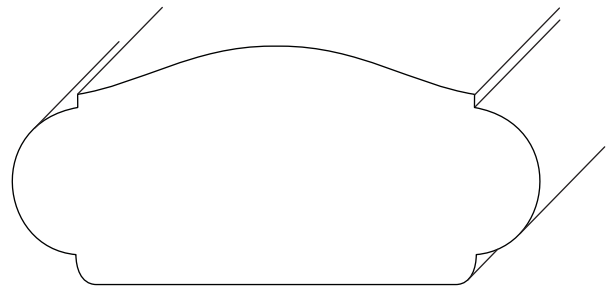

**114-1**  
2 3/4" x 1 1/4"



9469 South Bagley Park Road  
West Jordan, Utah 84088  
Phone: 801.280.2182 Fax: 801.280.2183

# Handrail

Available in Oak, Maple and Alder.  
Available in other species upon request.

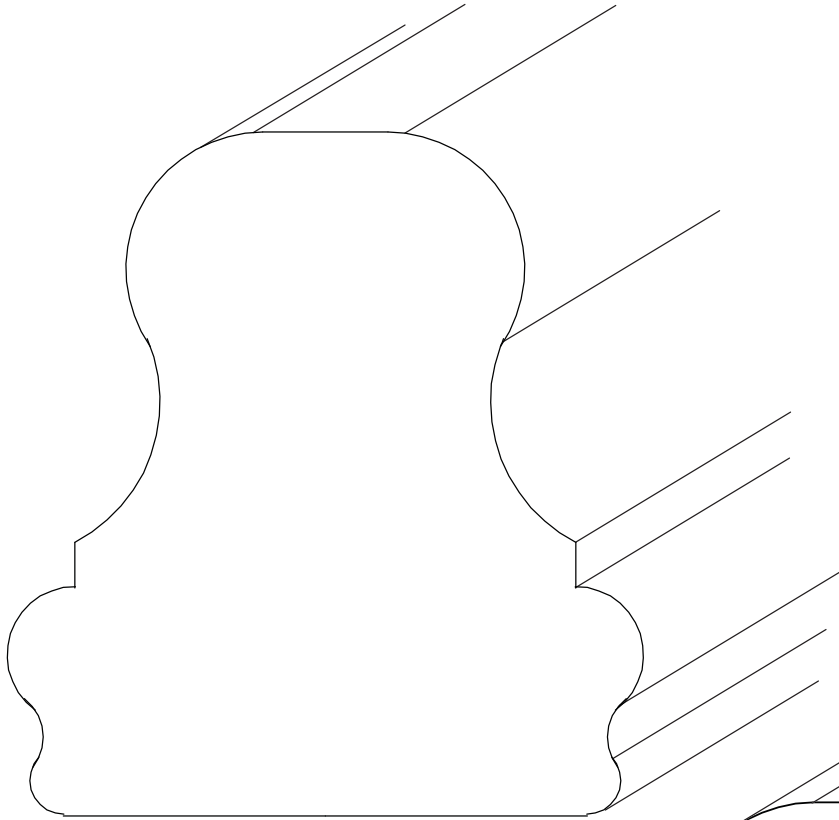

**HRL - 1**  
3 1/2" x 3 3/4"

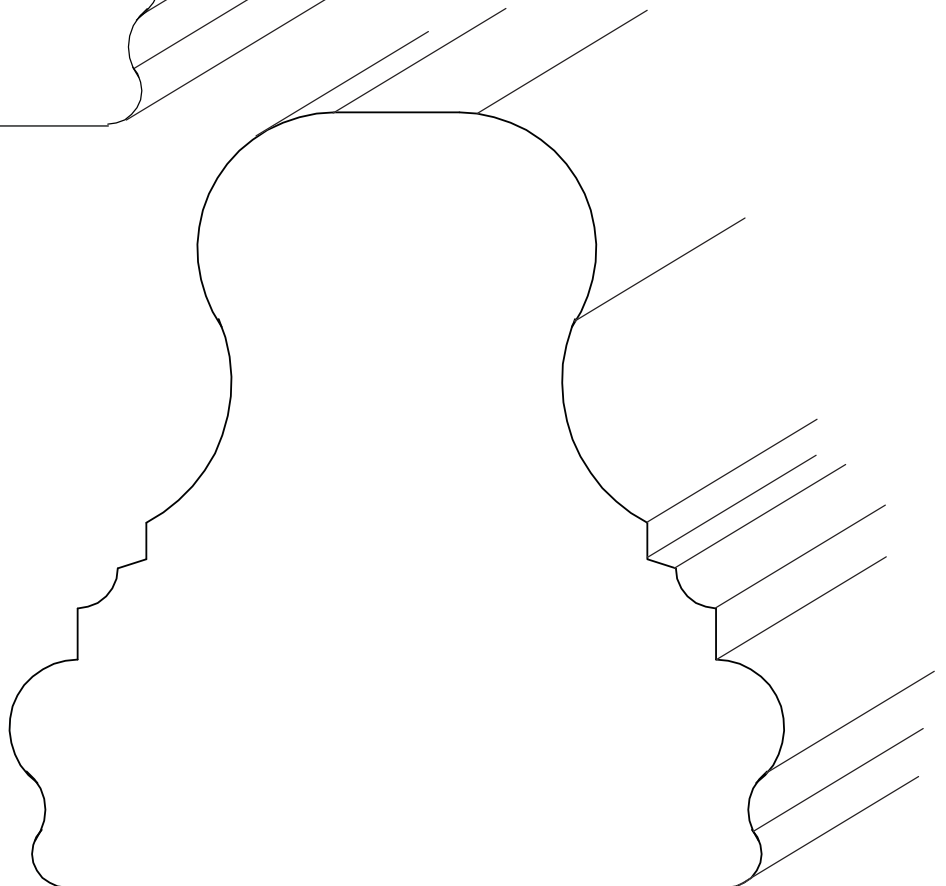

**HRL - 2**  
4 1/4" x 4 1/4"





9469 South Bagley Park Road  
West Jordan, Utah 84088  
Phone: 801.280.2182 Fax: 801.280.2183

# Bending Rail

Available in Oak, Maple and Alder.  
Available in other species upon request.

Our most common bending rail profiles are shown here. We manufacture additional profiles and offer our profiles in many different species. Our bending rail is manufactured to exacting specifications, with each slice being grain matched for a superior look. Bending mold is provided.

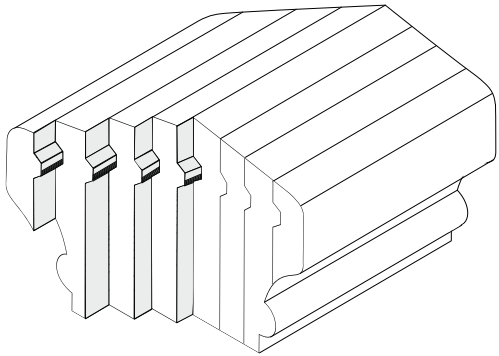

102-1

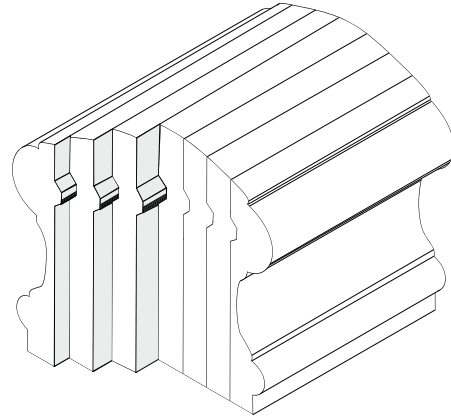

103-1

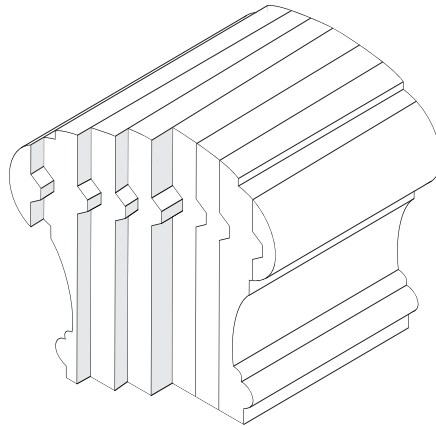

104-1

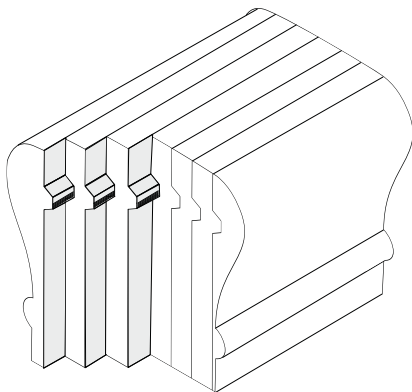

106-1

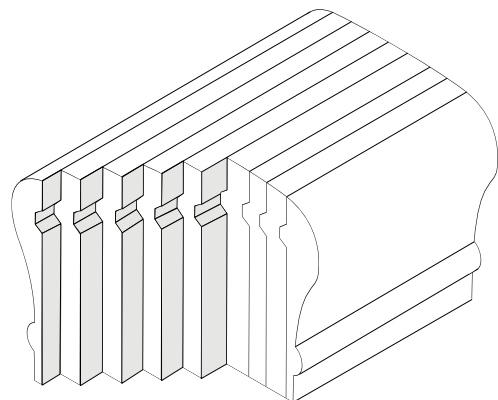

6210

\*Most profiles are available in tight bending rail.

\*\*Call for suggested rake and level radius limitations to which each profile can be bent.



9469 South Bagley Park Road  
 West Jordan, Utah 84088  
 Phone: 801.280.2182 Fax: 801.280.2183

# Panel Molding

Available in Oak, Maple and Alder.  
 Available in other species upon request.



**PM 1**  
 1 1/8" x 9/16"

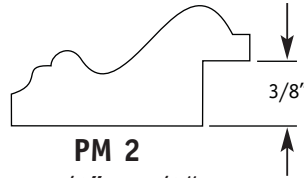

**PM 2**  
 1 1/4" x 5/8"

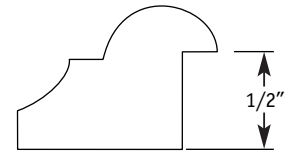

**PM 3**  
 1 1/16" x 3/4"

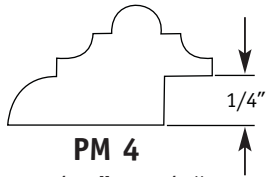

**PM 4**  
 1 1/16" x 5/8"

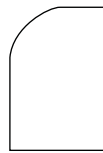

**Cap**  
 1/2" x 3/4"

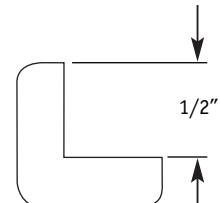

**Corner 1**  
 3/4" x 3/4"

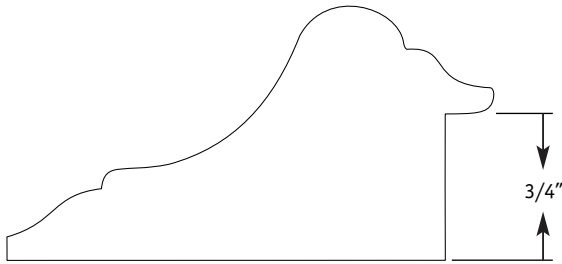

**PM 5**  
 2 1/2" x 1 3/8"

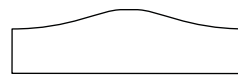

**F 3**  
 1 1/4" x 1/4"

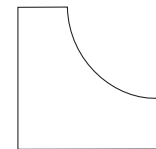

**SF 314**  
 5/8" x 5/8"



**SF 503**  
 3/8" x 3/4"

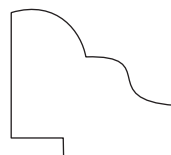

**SF 416**  
 (3/4" x 3/4")

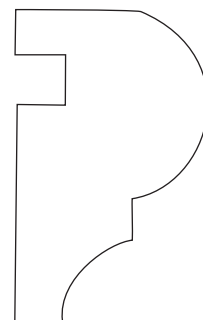

**SF 106**  
 1 5/8" x 1"



9469 South Bagley Park Road  
 West Jordan, Utah 84088  
 Phone: 801.280.2182 Fax: 801.280.2183

# Base & Case Molding

Available in Oak, Maple and Alder.  
 Available in other species upon request.

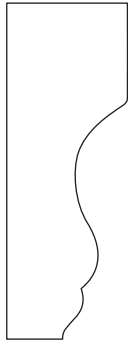

**CORNICE**  
 5/8" X 1 3/4"



**SF 199**  
 5/8" x 2 1/4"

## Chair Rail

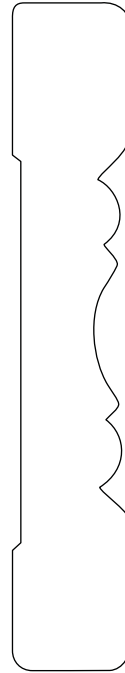

**CR 1**  
 5/8" x 3 1/2"

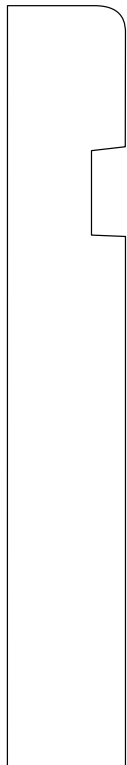

**B 1**  
 5/8" x 4"

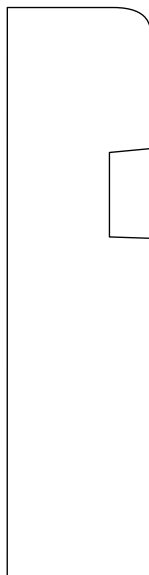

**C 1**  
 3/4" x 3"

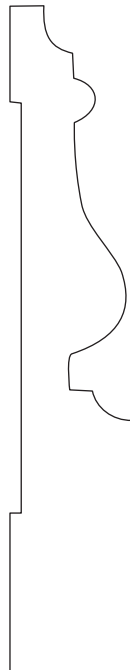

**B 2**  
 5/8" x 3 1/2"

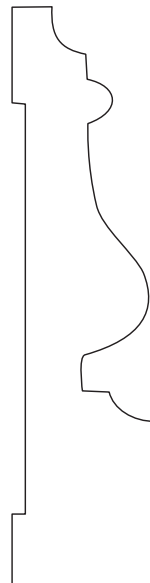

**C 2**  
 3/4" x 3"

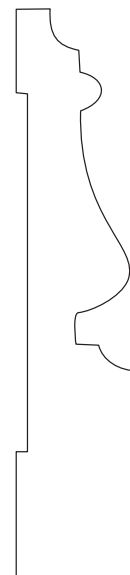

**B 4**  
 5/8" x 3"

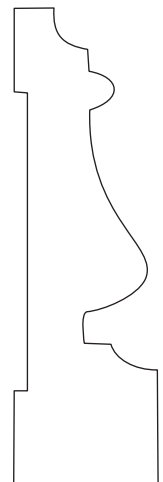

**C 4**  
 3/4" x 2 1/2"



9469 South Bagley Park Road  
West Jordan, Utah 84088  
Phone: 801.280.2182 Fax: 801.280.2183

# Base & Case Molding

Available in Oak, Maple and Alder.  
Available in other species upon request.

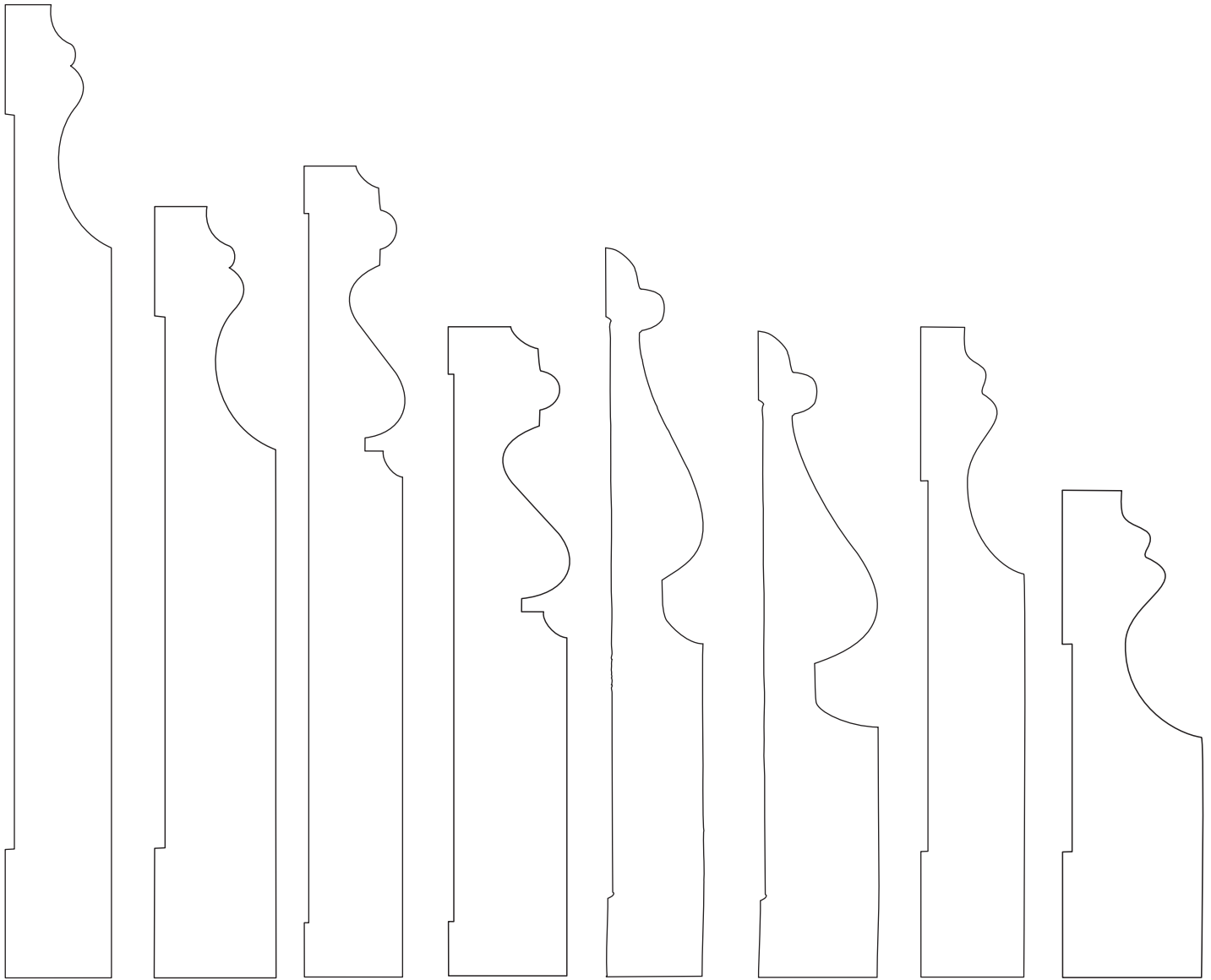

<b>B 5</b>	<b>C 5</b>	<b>B 6</b>	<b>C 6</b>	<b>B 7</b>	<b>C 7</b>	<b>B 8</b>	<b>C 8</b>
5/8" x 6"	3/4" x 4 3/4"	5/8" x 5"	3/4" x 4"	5/8" x 4 1/2"	3/4" x 4 1/2"	5/8" x 4"	3/4" x 3"



9469 South Bagley Park Road  
West Jordan, Utah 84088  
Phone: 801.280.2182 Fax: 801.280.2183

# Crown

Available in Oak, Maple and Alder.  
Available in other species upon request.

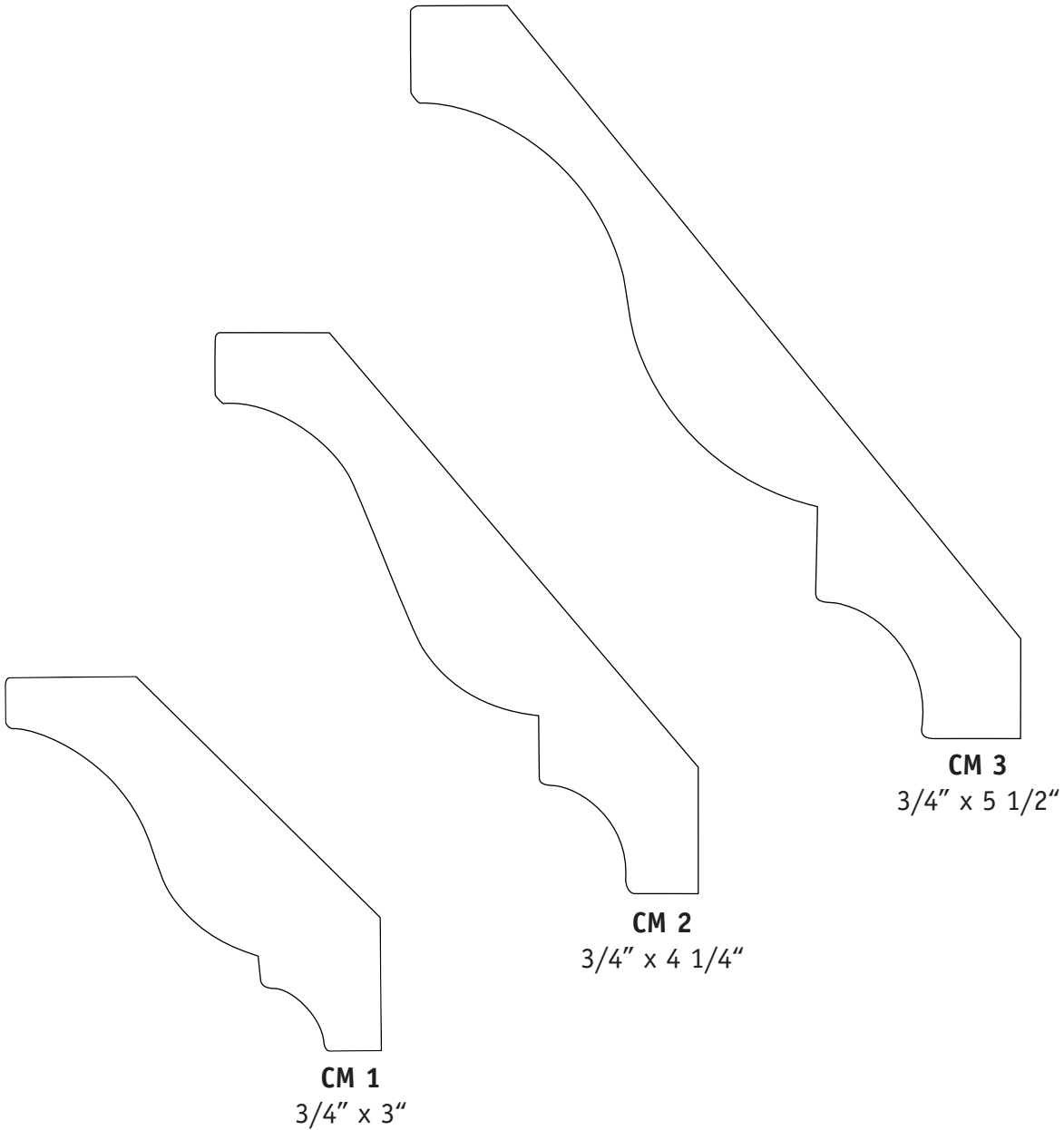



9469 South Bagley Park Road  
West Jordan, Utah 84088  
Phone: 801.280.2182 Fax: 801.280.2183

# Tongue & Groove

Available in Oak, Maple and Alder.  
Available in other species upon request.

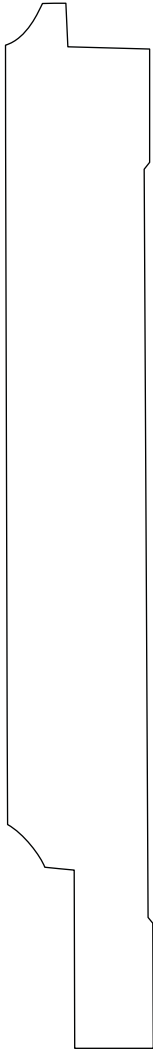

**TG 1**  
3/4" x 5 1/2"

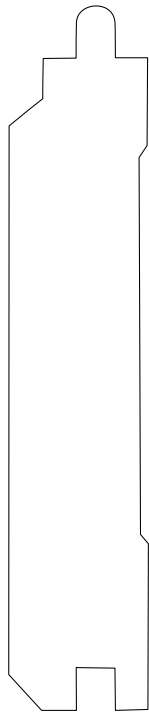

**TG 2**  
3/4" x 3 5/8"

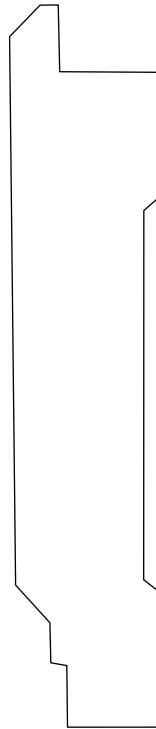

**TG 3**  
3/4" x 3 3/4"

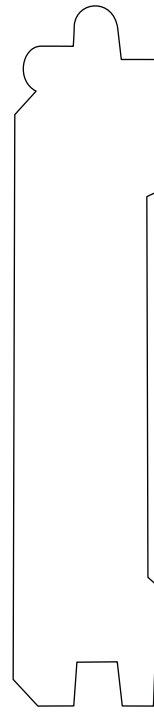

**TG 4**  
3/4" x 3 5/8"

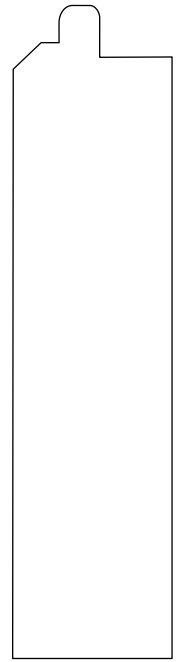

**TG 5**  
3/4" x 3 3/8"



9469 South Bagley Park Road  
 West Jordan, Utah 84088  
 Phone: 801.280.2182 Fax: 801.280.2183

# Fittings

Available in Oak, Maple and Alder.  
 Available in other species upon request.  
 Additional profiles are available.

Fittings available in the following profiles (\*other profiles available upon request)

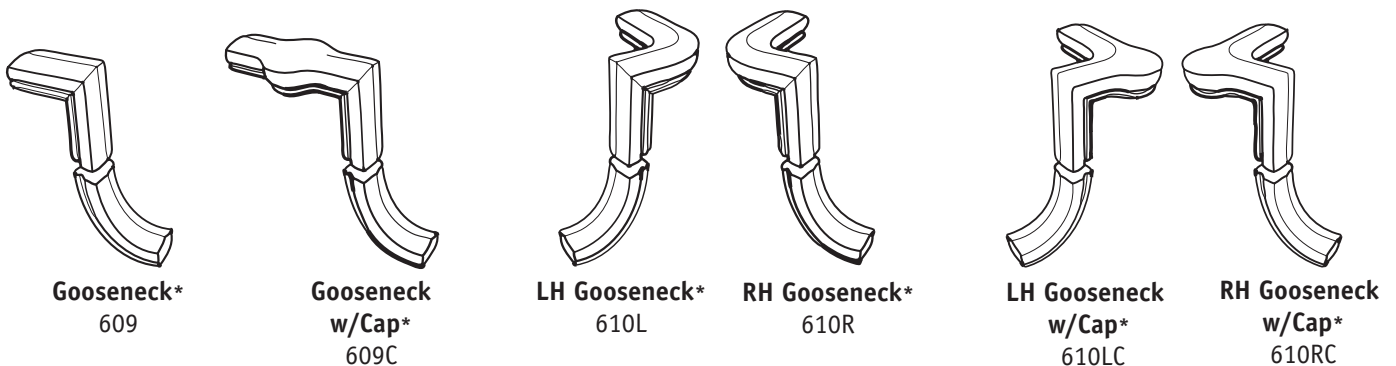
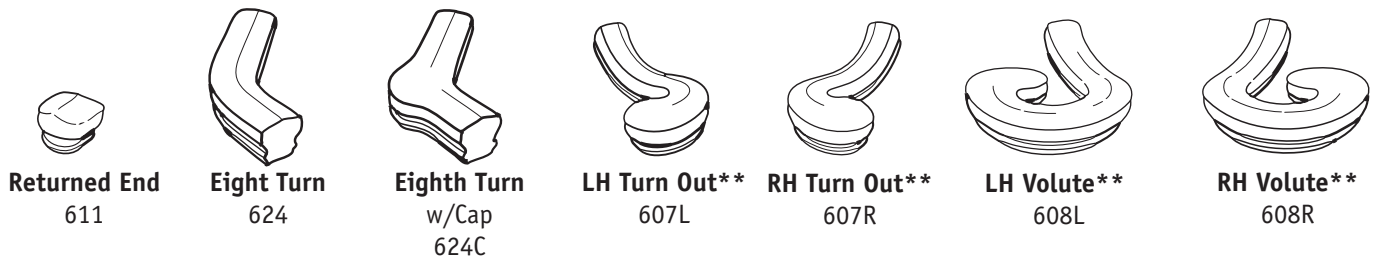
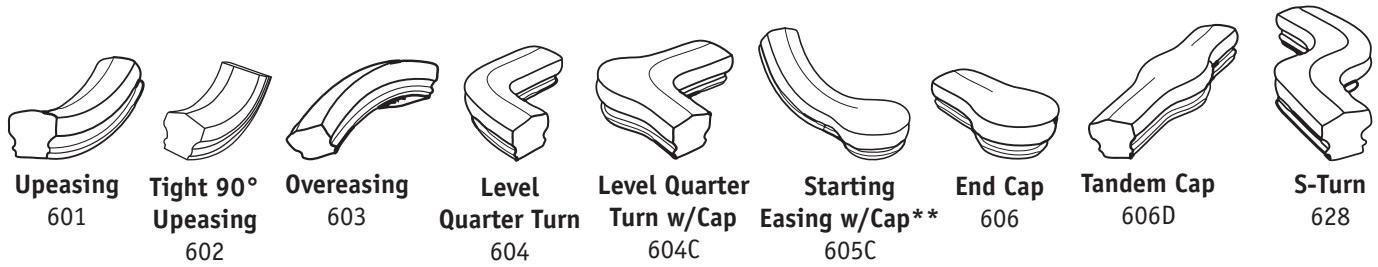
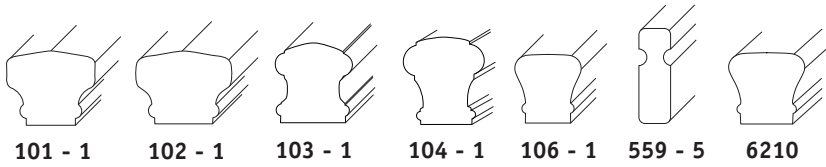

\*Easing not attached on any goosenecks.  
 \*\*Easing not attached unless specified.



9469 South Bagley Park Road  
 West Jordan, Utah 84088  
 Phone: 801.280.2182 Fax: 801.280.2183

# Shoe Rail, Treads, Rosettes, S4S, & Shoe Plate

Available in Oak, Maple and Alder.  
 Available in other species upon request.

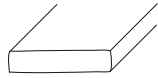

**Fillet**  
 (5/16" x 1 1/4") **Fillet 1.25**  
 (5/16" x 1 3/4") **Fillet 1.75**

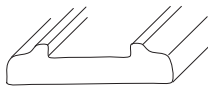

**Shoe Rail**  
 (3/4" x 3" - plow 1 1/4") **403-0P**  
 (3/4" x 3.5" - plow 1 3/4") **403-1P**

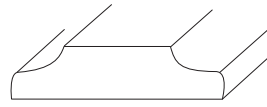

**Non Plow Shoe Rail**  
 (3/4" x 3" - non plow) **403-0**  
 (3/4" x 3.5" - non plow) **403-1**

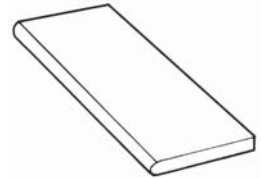

**Stair Tread**  
 1" x 11 1/2" **8070**  
 Treads are available Plain,  
 Return LH or RH, or Bullnose  
 Both Ends in the following  
 lengths: 36", 48", 54"



**False Riser 8076**  
 6" x 7 3/4"



**False Starting Step**  
 radius bullnose **8310-2**

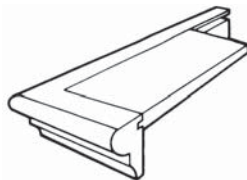

**Tread Caps**  
 RH (right hand) **8071R**  
 LH (left hand) **8071L**  
 6" x 11 5/8" (7" o.a.)

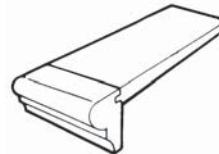

**Closed Tread Cap End**  
 6" x 11 5/8" **8072**

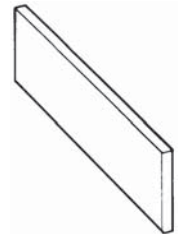

**Full Riser**  
 3/4" x 7 1/2" **Riser**  
 Risers are available in the  
 following lengths: 36", 48", 54"

## ACCESSORIES

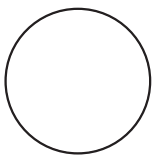

**Round Rosette 5014**  
 1" x 4 1/4" diameter

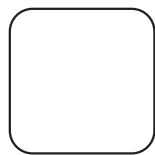

**Square Rosette 5034**  
 1" x 4"



**Rectangle Rosette 5084**  
 1" x 4 1/2" x 6 1/4"

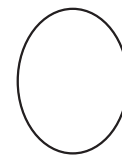

**Oval Rosette 5044**  
 1" x 4" x 5 1/2"

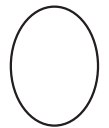

**Small Oval Rosette 5064**  
 1" x 3 1/2" x 6"

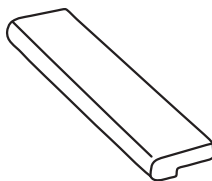

**Landing Tread 8090**  
 1" x 6"

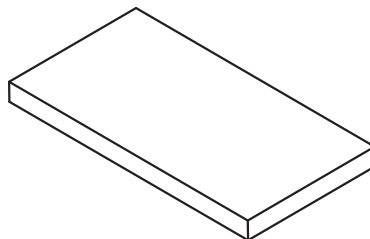

**S4S**  
 3/4" x 4" Apron **604**  
 3/4" x 5 1/2" **605**  
 3/4" x 7 1/4" **607**  
 3/4" x 11 1/4" Skirt **611**

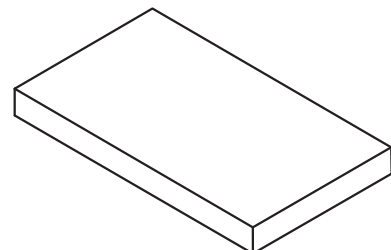

**Shoe Plate**  
 1" x 6" **406**, 1" x 7.5" **475**, 1" x 8" **408**  
**Bending Shoe Plate**  
 1" x 6" **406B**, 1" x 7.5" **475B**, 1" x 8" **408B**





9469 South Bagley Park Road  
 West Jordan, Utah 84088  
 Phone: 801.280.2182 Fax: 801.280.2183

# Box Newels

Available in Oak, Maple and Alder.  
 Available in other species and sizes upon request.

## Hollow Posts Come In

4 3/4", 5",  
 5 1/2", 6",  
 and 8"

## Solid Posts Come In

3", 3 1/2",  
 4", and 4 1/2"

**This is a sample of the options  
 a newel can come with.**

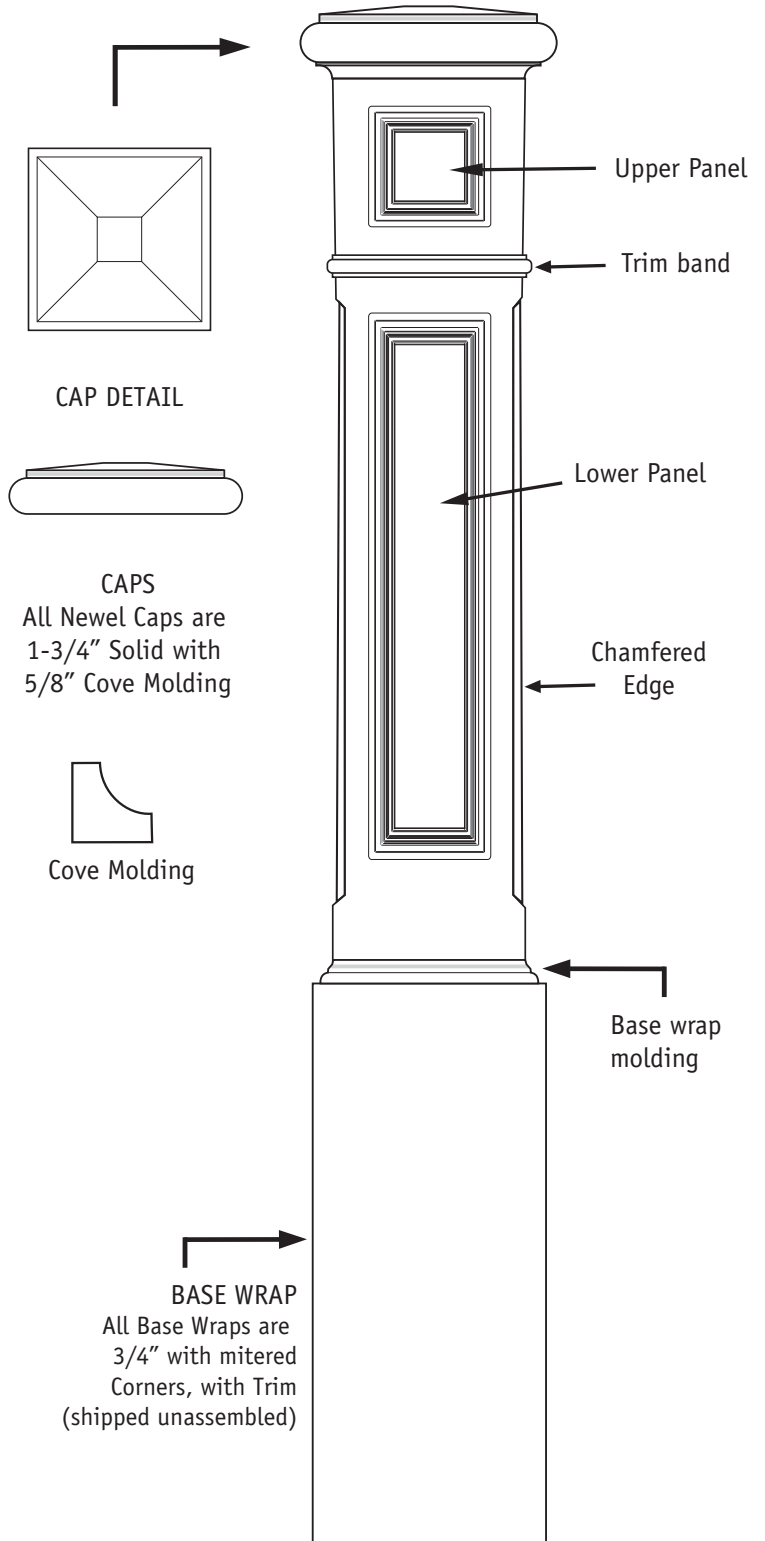
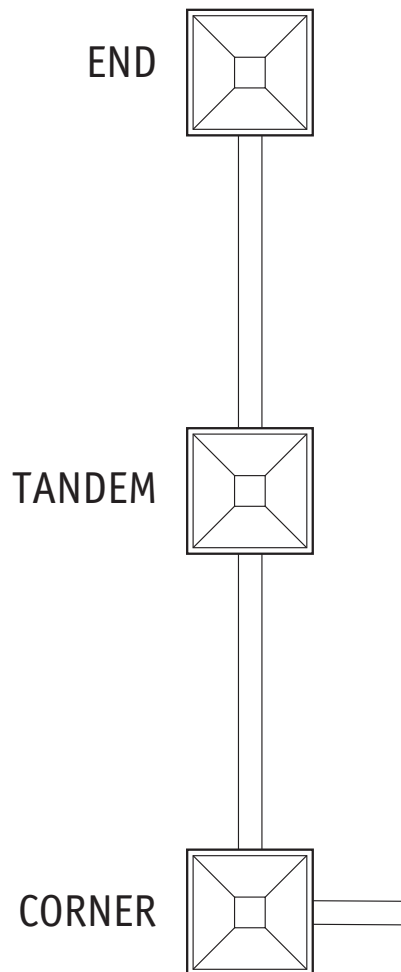



9469 South Bagley Park Road  
West Jordan, Utah 84088  
Phone: 801.280.2182 Fax: 801.280.2183

Available in Oak, Maple and Alder.  
Available in other species upon request.

## Newel panels available in the following styles.

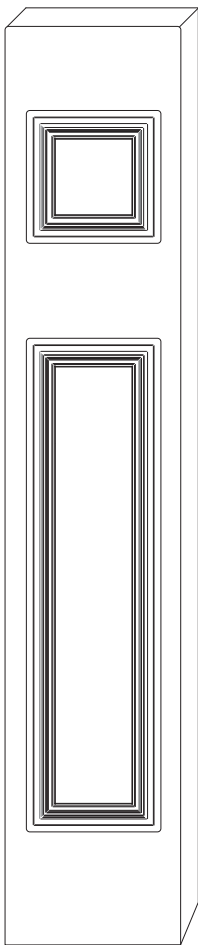

**Plant-on Panel**

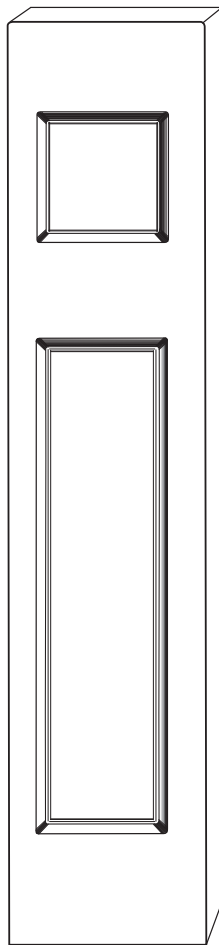

**Recessed Panel**

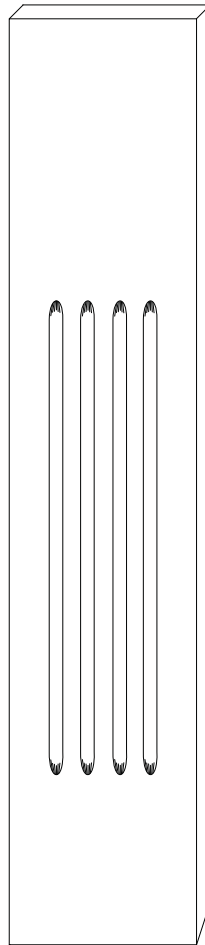

**Fluted Panel**

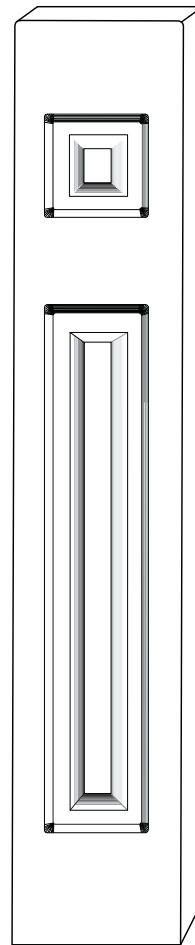

**Raised Panel**

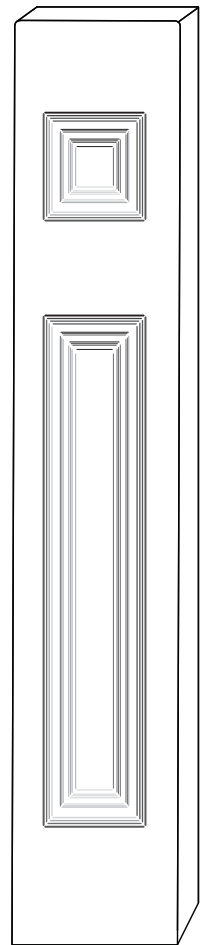

**Recessed Panel  
with Panel Mold**



9469 South Bagley Park Road  
West Jordan, Utah 84088  
Phone: 801.280.2182 Fax: 801.280.2183

# Plant-on Newels

Available in Oak, Maple and Alder.  
Available in other species upon request.

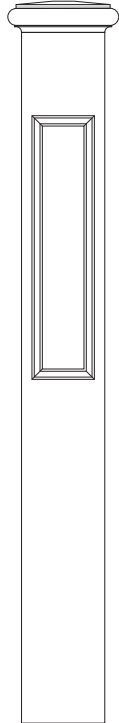
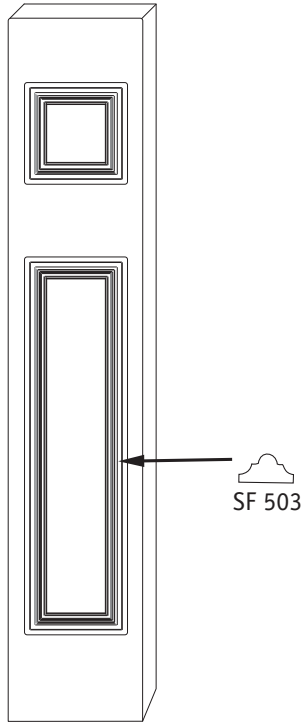

#1

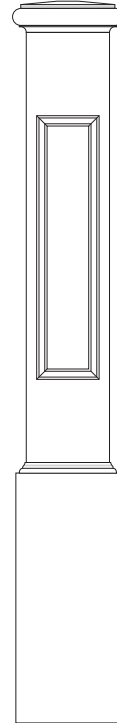

#2

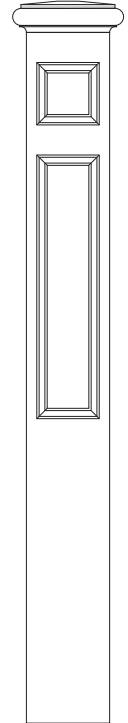

#3

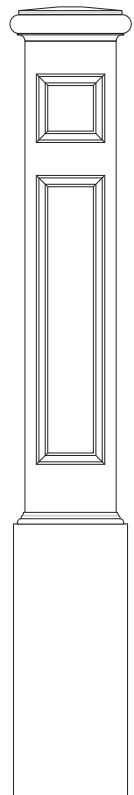

#4

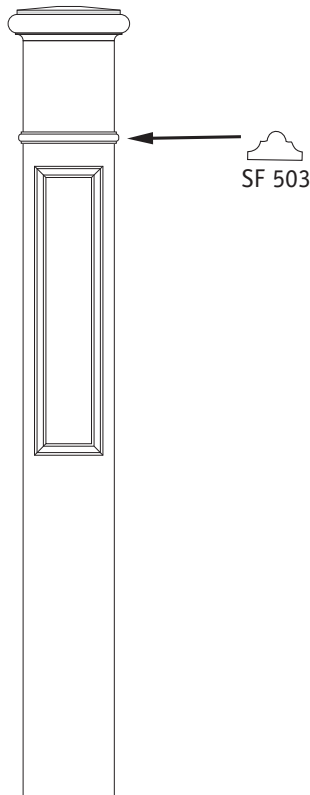

#5

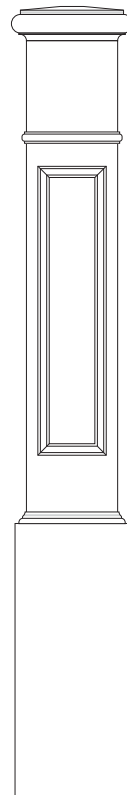

#6

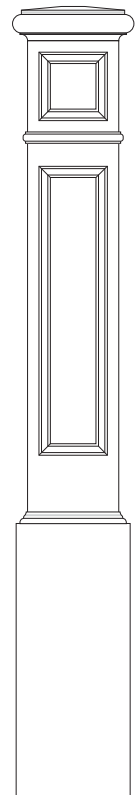

#7



9469 South Bagley Park Road  
West Jordan, Utah 84088  
Phone: 801.280.2182 Fax: 801.280.2183

# Newels

Available in Oak, Maple and Alder.  
Available in other species upon request.

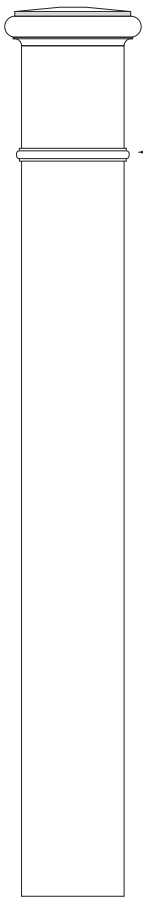

#8

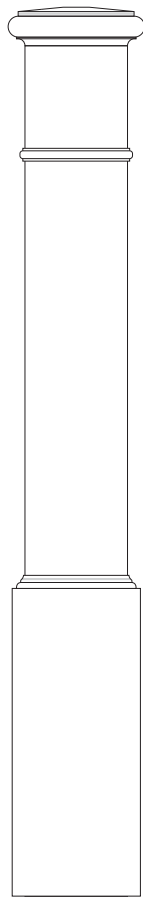

#9

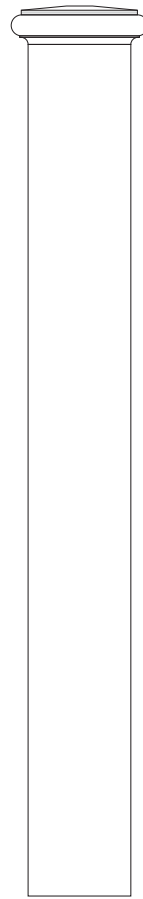

#10

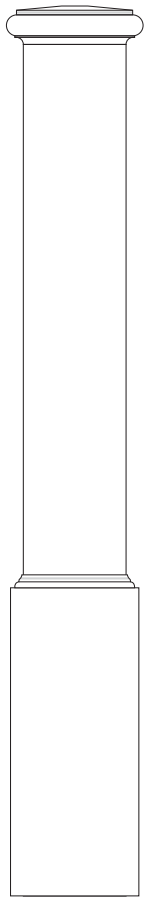

#11



9469 South Bagley Park Road  
West Jordan, Utah 84088  
Phone: 801.280.2182 Fax: 801.280.2183

# Recessed Newels

Available in Oak, Maple and Alder.  
Available in other species upon request.

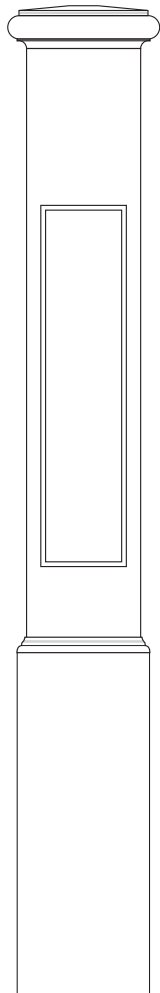
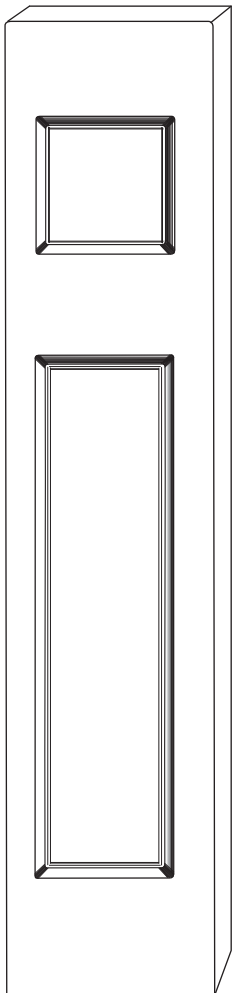

#12

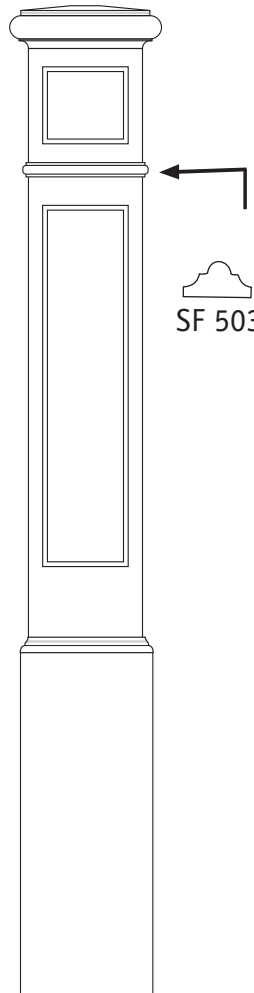

#13

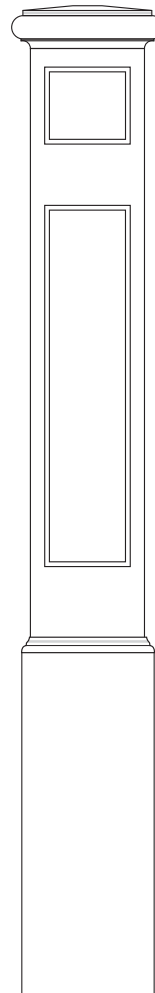

#14

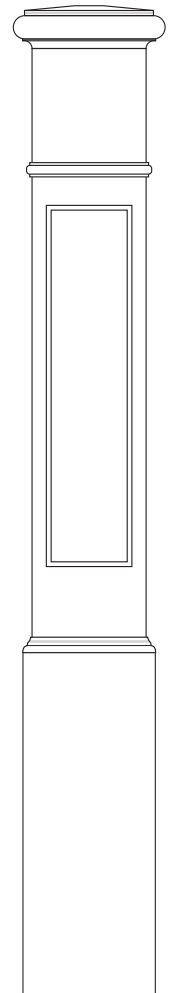

#15



9469 South Bagley Park Road  
West Jordan, Utah 84088  
Phone: 801.280.2182 Fax: 801.280.2183

# Fluted & Chamfered Newels

Available in Oak, Maple and Alder.  
Available in other species upon request.

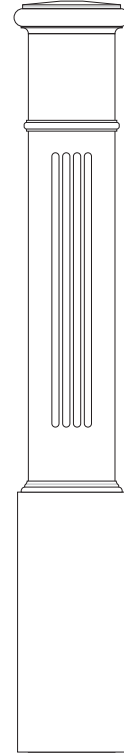
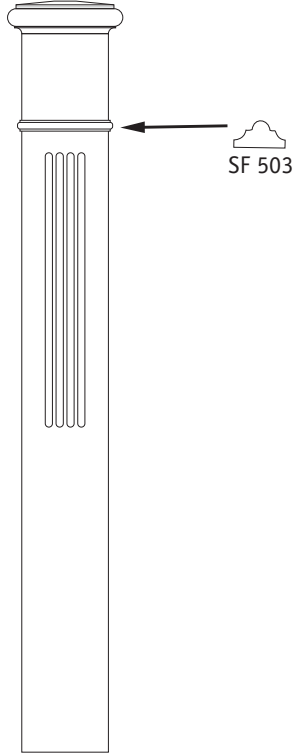
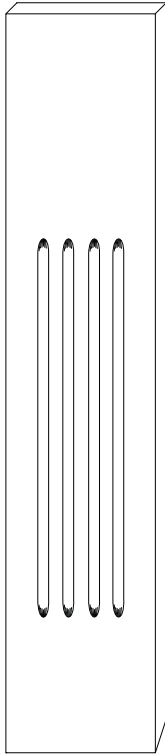

#16

#17

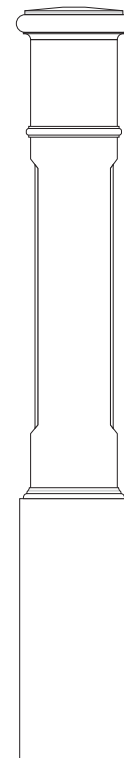
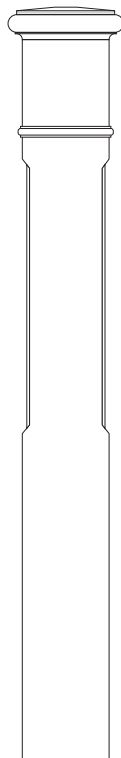
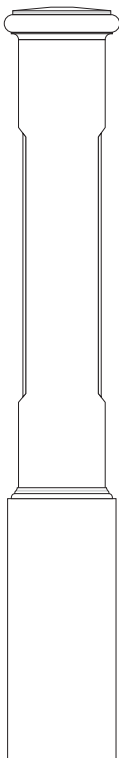

#18

#19

#20



9469 South Bagley Park Road  
West Jordan, Utah 84088  
Phone: 801.280.2182 Fax: 801.280.2183

# Raised Panel Newel

Available in Oak, Maple and Alder.  
Available in other species upon request.

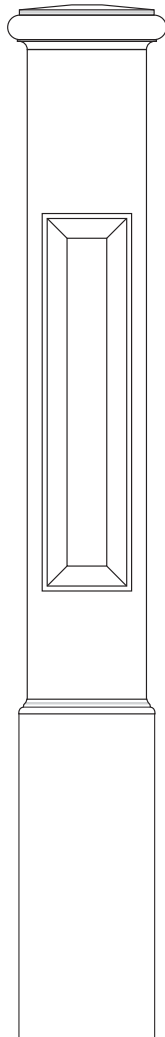
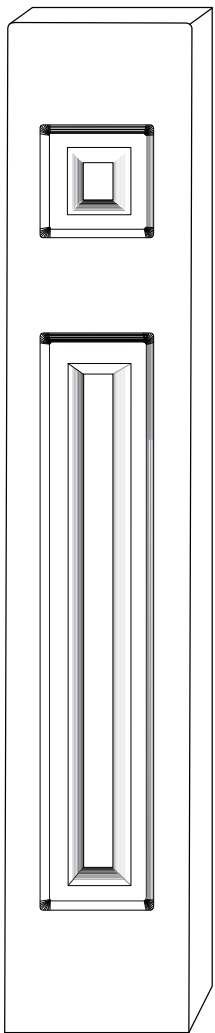

#21

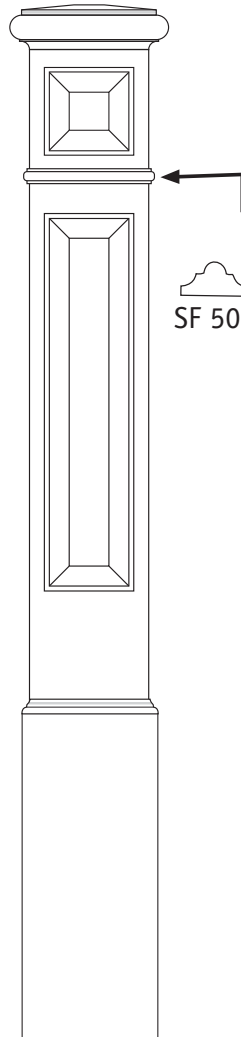

#22

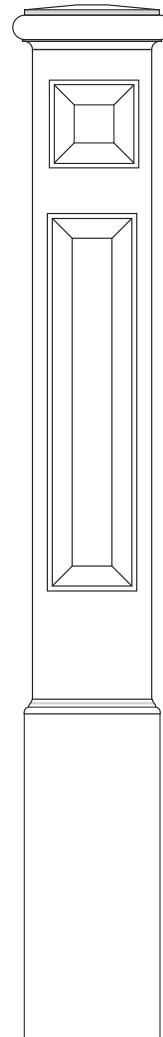

#23

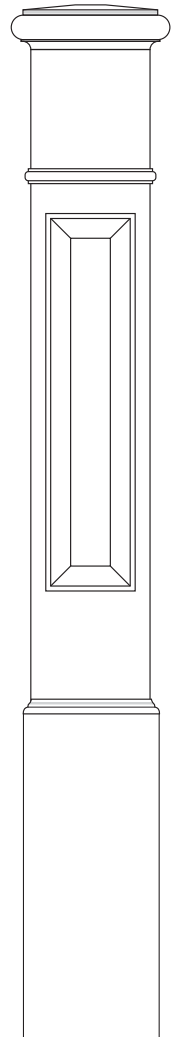

#24



9469 South Bagley Park Road  
West Jordan, Utah 84088  
Phone: 801.280.2182 Fax: 801.280.2183

# Recessed Panel with Panel Mold

Available in Oak, Maple and Alder.  
Available in other species upon request.

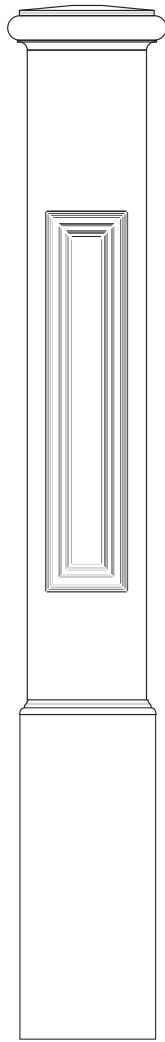
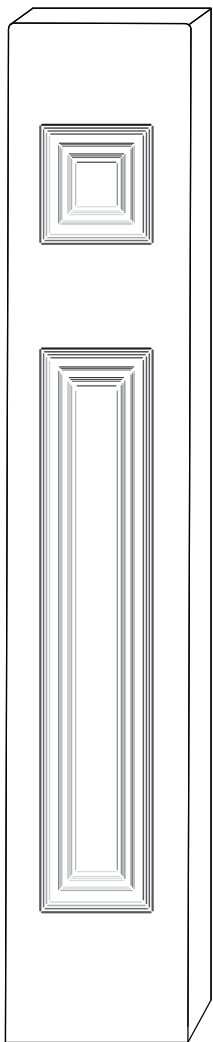

#25

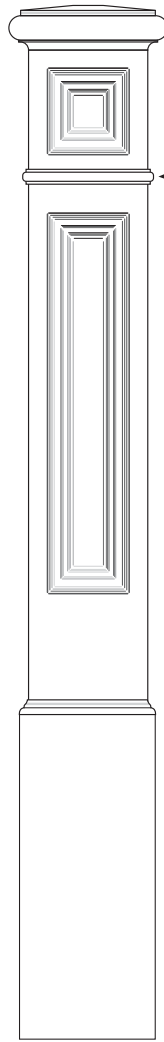

#26

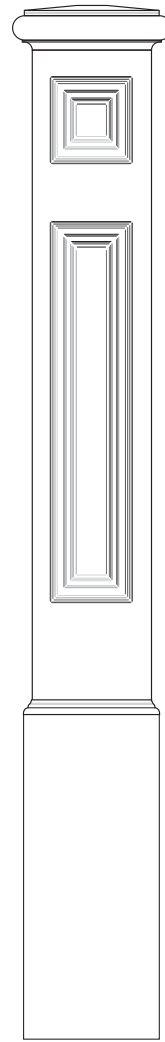

#27

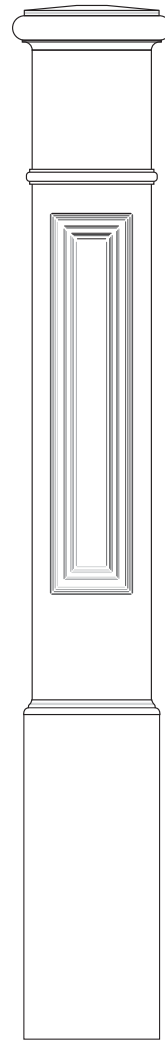

#28





9469 South Bagley Park Road  
 West Jordan, Utah 84088  
 Phone: 801.280.2182 Fax: 801.280.2183

# Turned Newels

Available in Oak, Maple and Alder.  
 Available in other species upon request.  
 Many other turning available. Just ask!

## URN-SHAPED TURNING

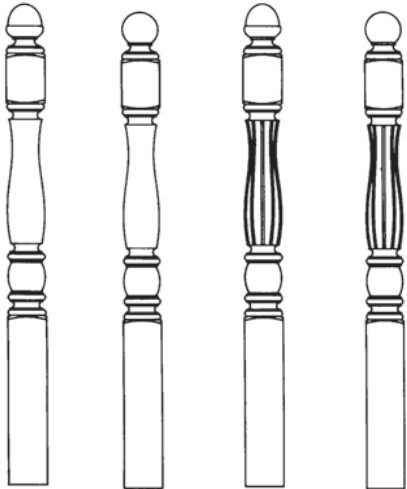

	<b>Acorn Top</b>	<b>Ball Top</b>	<b>Fluted Acorn</b>	<b>Fluted Ball</b>
3":	210A	210B	210FA	210FB
3 1/2":	211A	211B	211FA	211FB
3":	210LBA	210LBB	210LBFA	210LBFB
3 1/2":	211LBA	211LBB	211LBFA	211LBFB

## STRAIGHT TAPERED TURNING

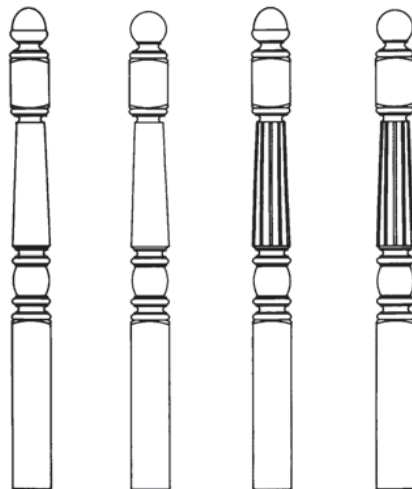

	<b>Acorn Top</b>	<b>Ball Top</b>	<b>Fluted Acorn</b>	<b>Fluted Ball</b>
	220A	220B	220FA	220FB
	221A	221B	221FA	221FB
	220LBA	220LBB	220LBFA	220LBFB
	221LBA	221LBB	221LBFA	221LBFB

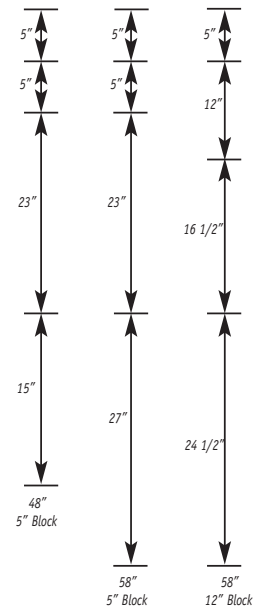

## DOWEL TOP

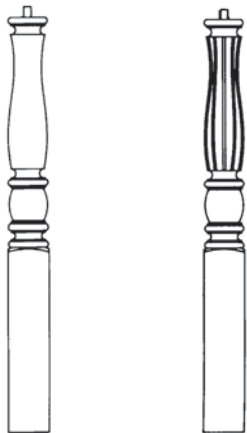

	<b>Dowel Top</b>	<b>Fluted Dowel</b>
3":	210D	210FD
3 1/2":	211D	211FD

## DOWEL TOP

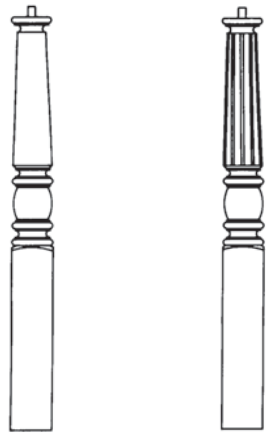

	<b>Dowel Top</b>	<b>Fluted Dowel</b>
	220D	220FD
	221D	221FD

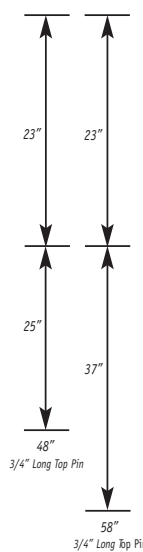

## NEWEL BLANKS

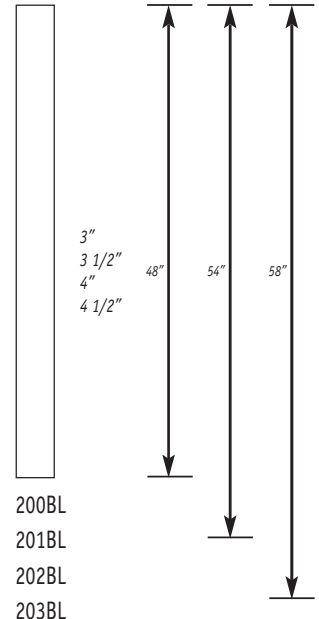



9469 South Bagley Park Road  
 West Jordan, Utah 84088  
 Phone: 801.280.2182 Fax: 801.280.2183

# Balusters

Available in Oak, Maple and Alder.  
 Available in other species upon request.  
 Many other turning available. Just ask!

## URN-SHAPED TURNING

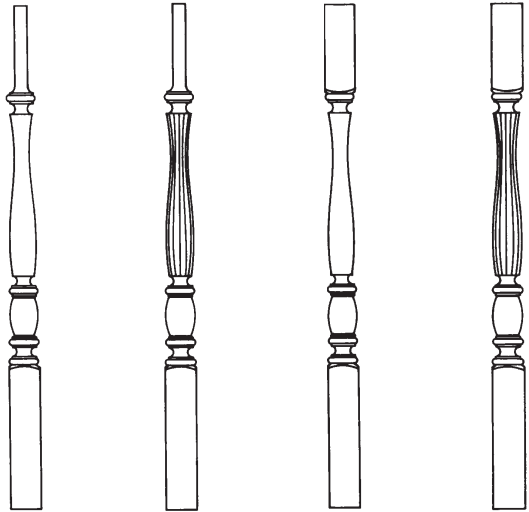

Pin-Top  
Top

Fluted  
Round  
Top

Square  
Top

Fluted  
Square  
Top

310PT 1 1/4"  
311PT 1 3/4"

311FPT 1 3/4"

310ST 1 1/4"  
311ST 1 3/4"

311FST 1 3/4"

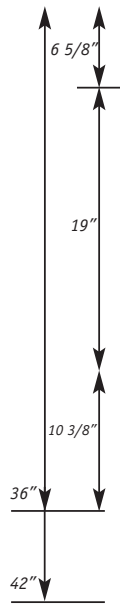

## STRAIGHT TAPERED TURNING

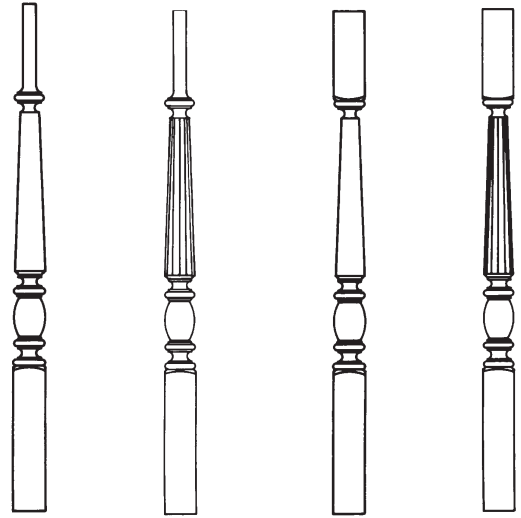

Pin-Top  
Top

Fluted  
Round  
Top

Square  
Top

Fluted  
Square  
Top

320PT 1 1/4"  
321PT 1 3/4"

321FPT 1 3/4"

320ST 1 1/4"  
321ST 1 3/4"

321FST 1 3/4"

## BALUSTER BLANKS, CHAMFERED & PIN TOP BALUSTERS

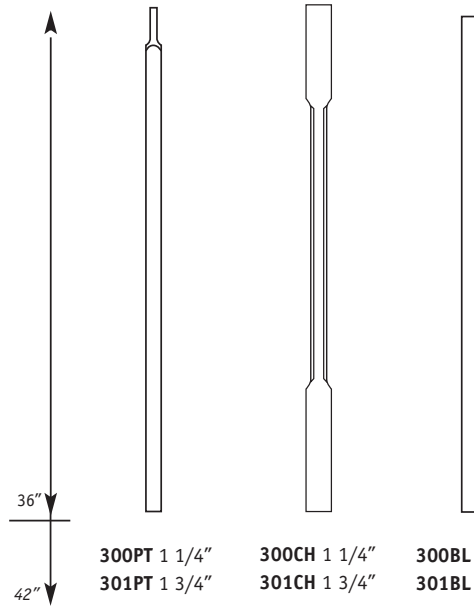

300PT 1 1/4"  
301PT 1 3/4"

300CH 1 1/4"  
301CH 1 3/4"

300BL 1 1/4"  
301BL 1 3/4"

Available in  
1 1/4"  
1 3/4"